

UHR-CR34610-TSO

Technical Datasheet



HiRate™

Features

- RTCA/DO-227 (TSO-142A)
- High energy density
- No voltage delay
- Wide operating temperature range
- Lightweight
- Up to 5-year shelf life
- 1% annual self-discharge @ 23°C for 10 years
- Long operating life
- Cell is hermetically sealed Ni-plated steel can

Applications

- Emergency Locator Transmitters (ELT) devices
- Consumer telematics
- Commercial telematics
- Search & rescue devices
- Military communications, detectors & imaging
- Medical devices

Technical Specifications

Part No.	U10028, U10029 U10028-T1, U10029-T1: optional Ni tabs
Voltage Range	1.5 to 3.3V
Average Voltage	3.0V
Nominal Capacity	11.1Ah @ 250mA to 2.0V @ 23°C
Max. Discharge	1.0A continuous
Pulse Capability	Up to 7.0A Varies according to pulse characteristics, temperature, cell history and the application. If application requires a pulse current exceeding 1A, additional testing may be required per TSO-142A. Consult Ultralife.
PTC	U10028 has PTC (re-settable fuse) U10029 do NOT
Weight	U10028 Bare cell: 121.35g U10028 Completed assembly: 123.48g U10028-T1 Bare cell: 121.35g U10028-T1 Completed assembly: 123.85g U10029 Bare cell: 121.10g U10029 Completed assembly: 123.23g U10029-T1 Bare cell: 121.10g U10029-T1 Completed assembly: 123.60g
Operating Temperature	-40°C to 72°C
Storage Temperature	-40°C to 95°C
Exterior/Housing	Hermetic Ni-plated steel can with Mylar sleeve
Terminals/Connector	Flat Ni-plated +/- End Caps: U10028 and U10029 Nickel tabs .005" x .187": U10028-T1 and U10029-T1
Safety	Material Safety Datasheet - MSDS023 Safety Guide UBM-5135
Transportation	Class 9 - U.S. and International (see note) RTCA/DO-227 (TSO-142A)
Note	A complete description of transportation regulations, lithium weights and transportation classifications is available on the Ultralife website.

Dimensions

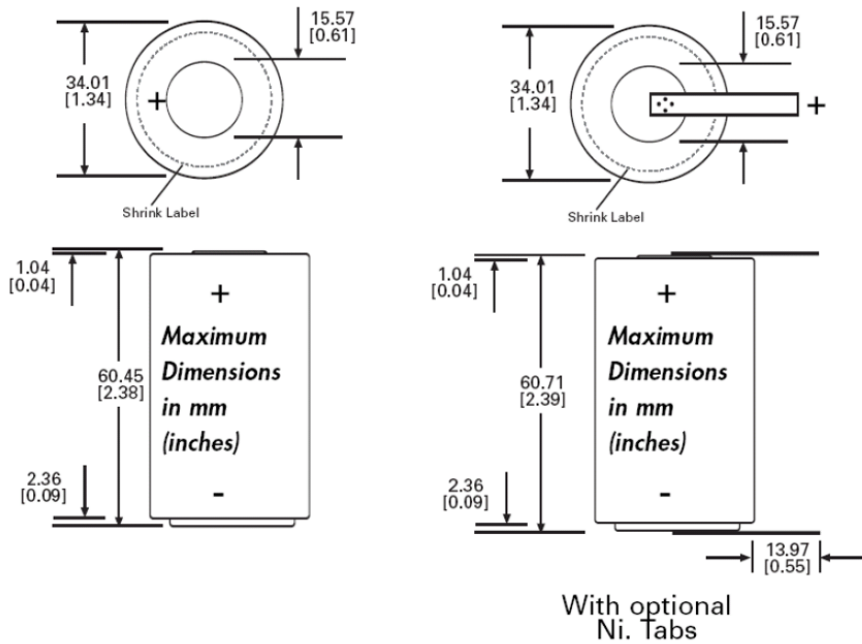

Performance Graphs

